

LAMBERT • EZELL • DURHAM
ARCHITECTURE, LLC
FLORENCE, ALABAMA 36631
P.O. BOX 494 401 EAST COLLEGE ST.
WWW.LEDARCHITECTURE.COM
TELEPHONE (256) 161-1100

BRANCH BANK FOR
TRADERS AND FARMERS BANK
DOUBLE SPRINGS, ALABAMA

JOB NO. 1612
DATE 11/30/17
DRAWN JBK
CHECKED CED
REVISOR
REVISED

DRAWING TITLE
INTERIOR ELEVATIONS
DRAWING NUMBER
A-13
OF 15

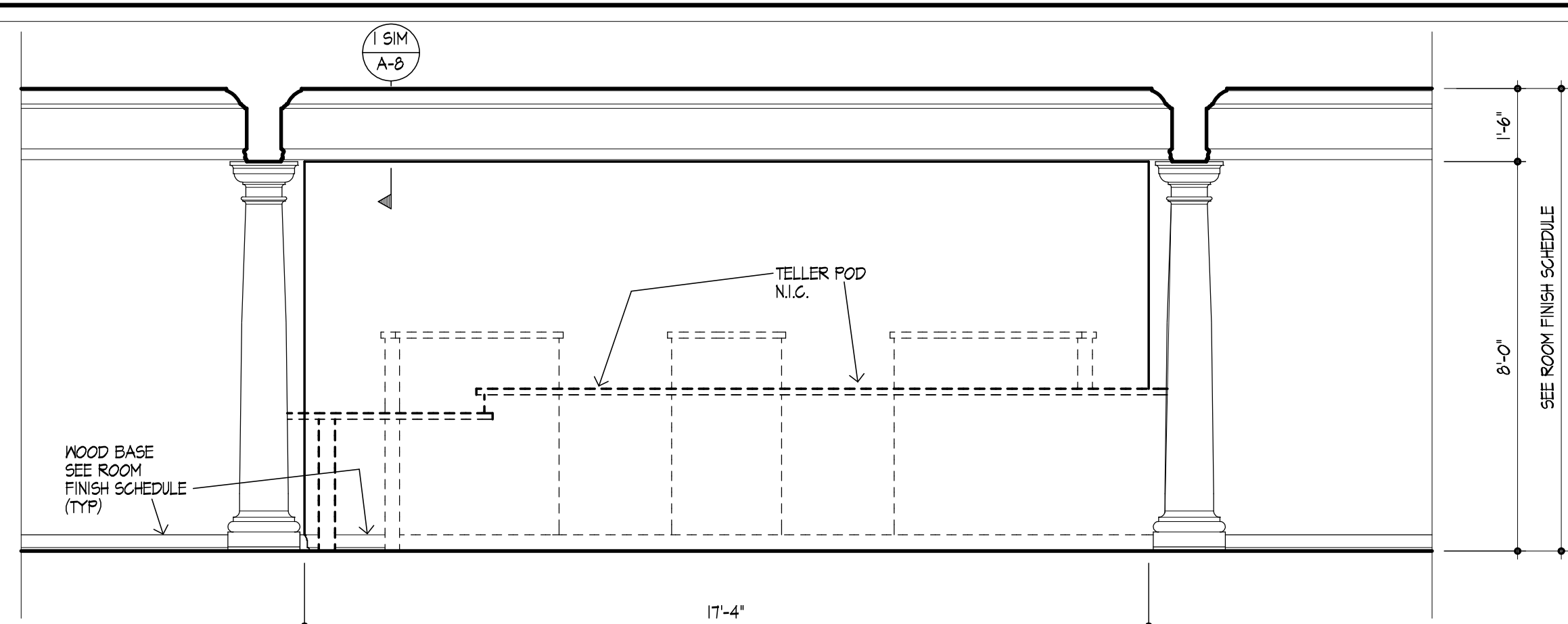

1 ELEVATION
TELLERS 114

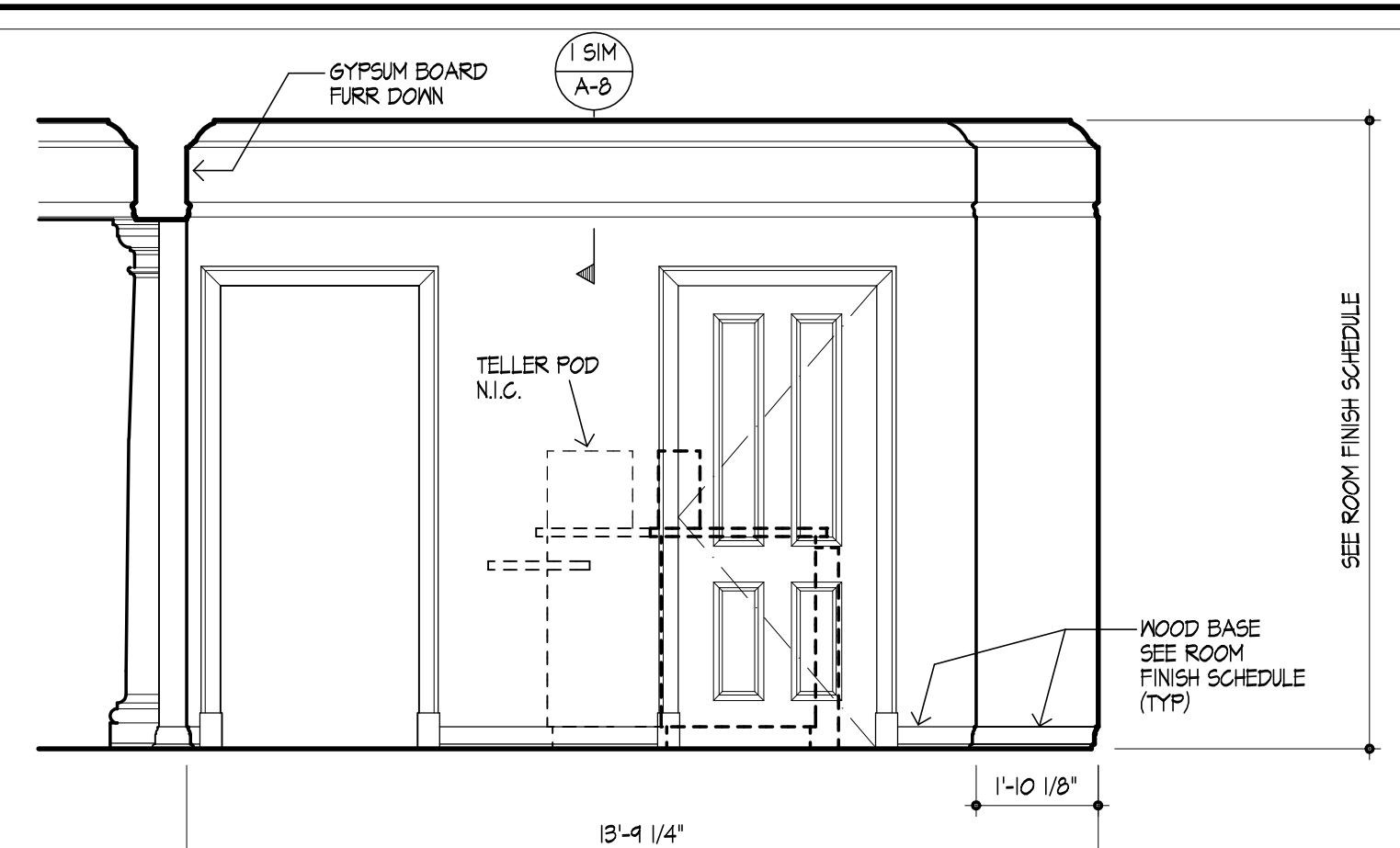

3 ELEVATION
TELLERS 114

2 NOT USED

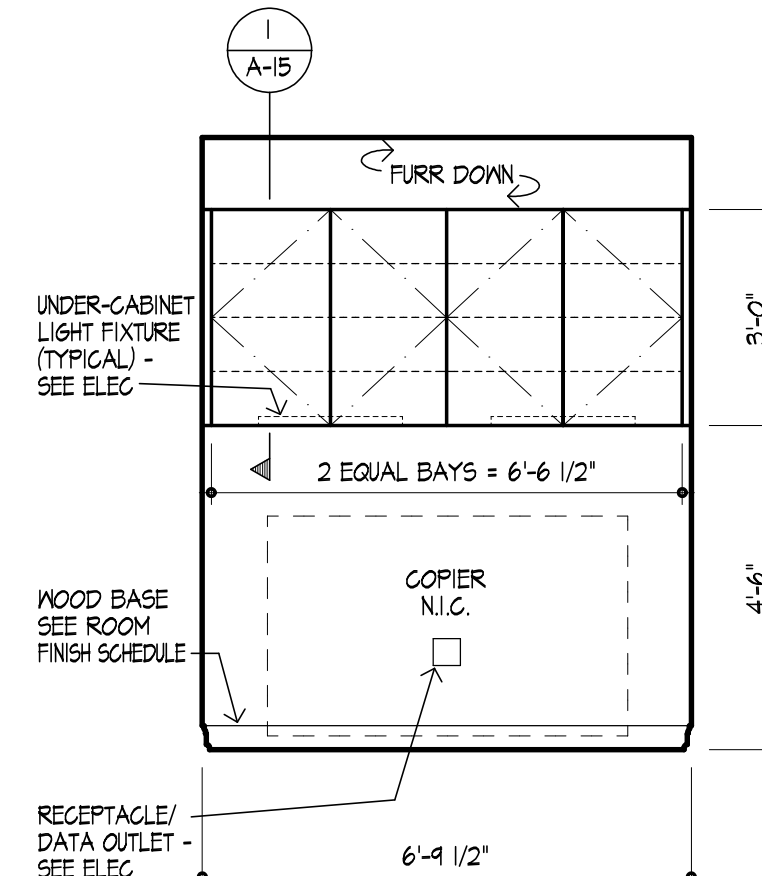

5 ELEV
PRINTER ALCOVE 110

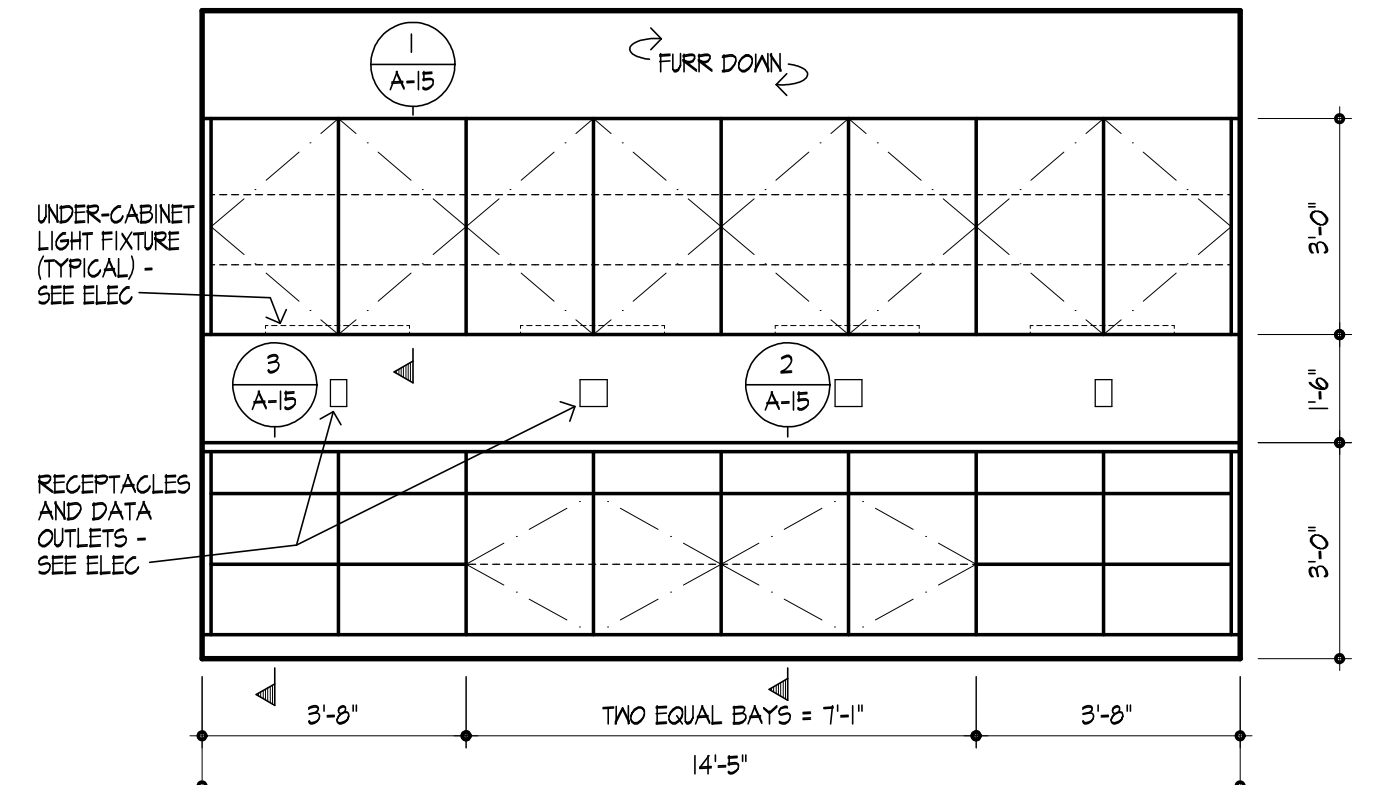

6 ELEVATION
WORKROOM 111

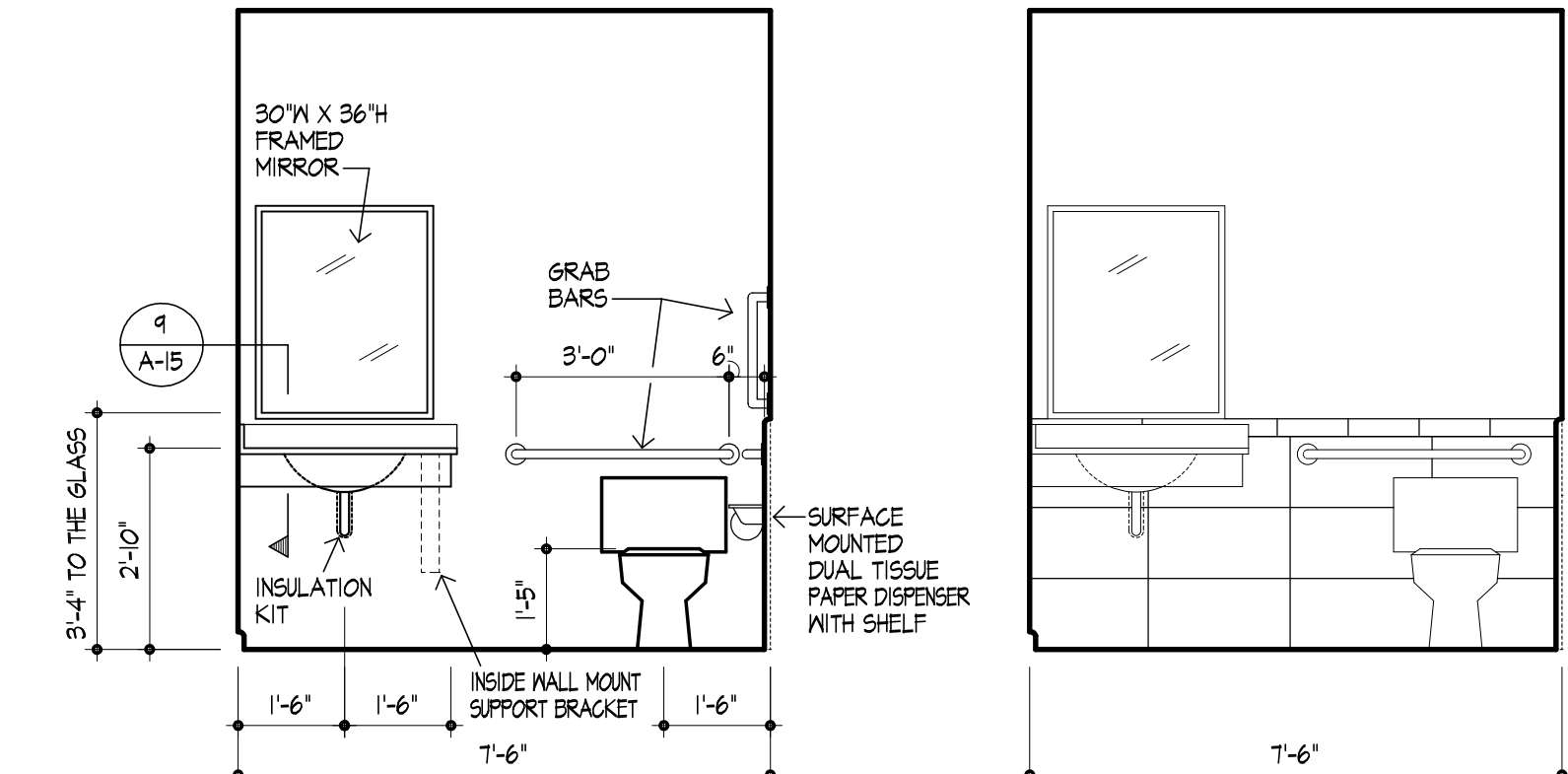

7 ELEVATION
TOILET 113

THIS ELEVATION IS FOR TILE PATTERN REPRESENTATION ONLY. EACH WALL WITH WALL TILE IN TOILET 113 IS REPRESENTED IN ELEVATION. WALLS NOT REPRESENTED DO NOT HAVE WALL TILE.

4 NOT USED

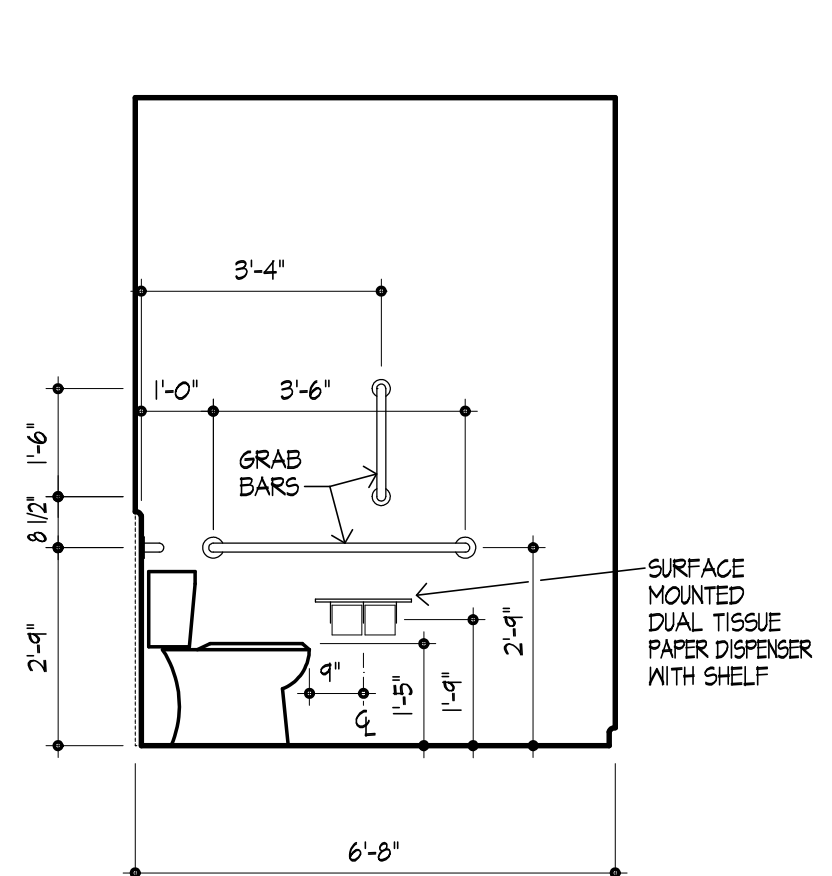

8 ELEVATION
TOILET 113

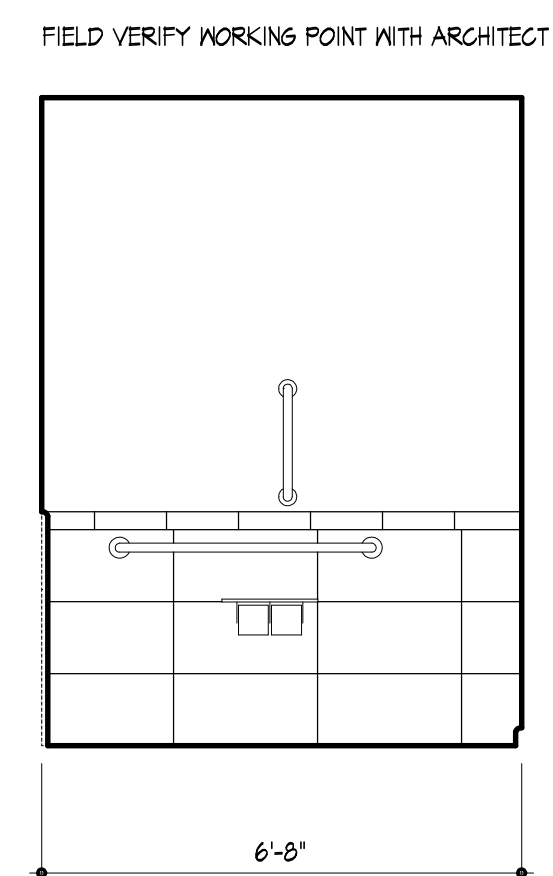

9 ELEVATION
TOILET 113

THIS ELEVATION IS FOR TILE PATTERN REPRESENTATION ONLY. EACH WALL WITH WALL TILE IN TOILET 113 IS REPRESENTED IN ELEVATION. WALLS NOT REPRESENTED DO NOT HAVE WALL TILE.

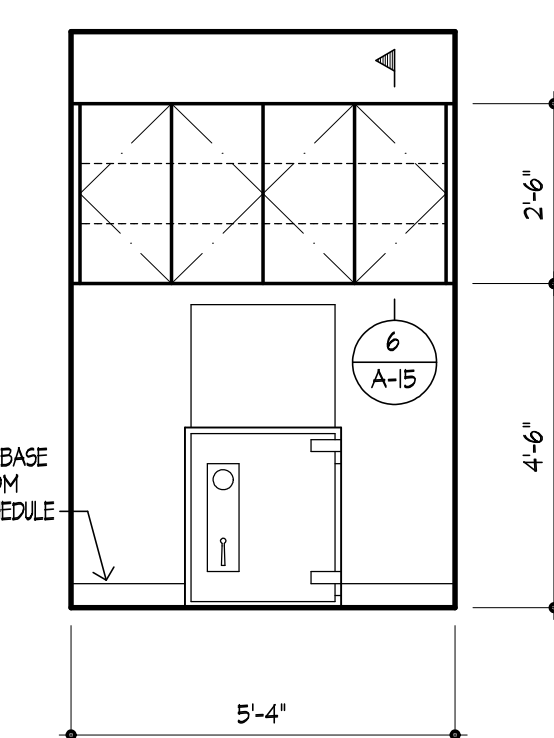

10 ELEV
NIGHT DEPOSIT 117

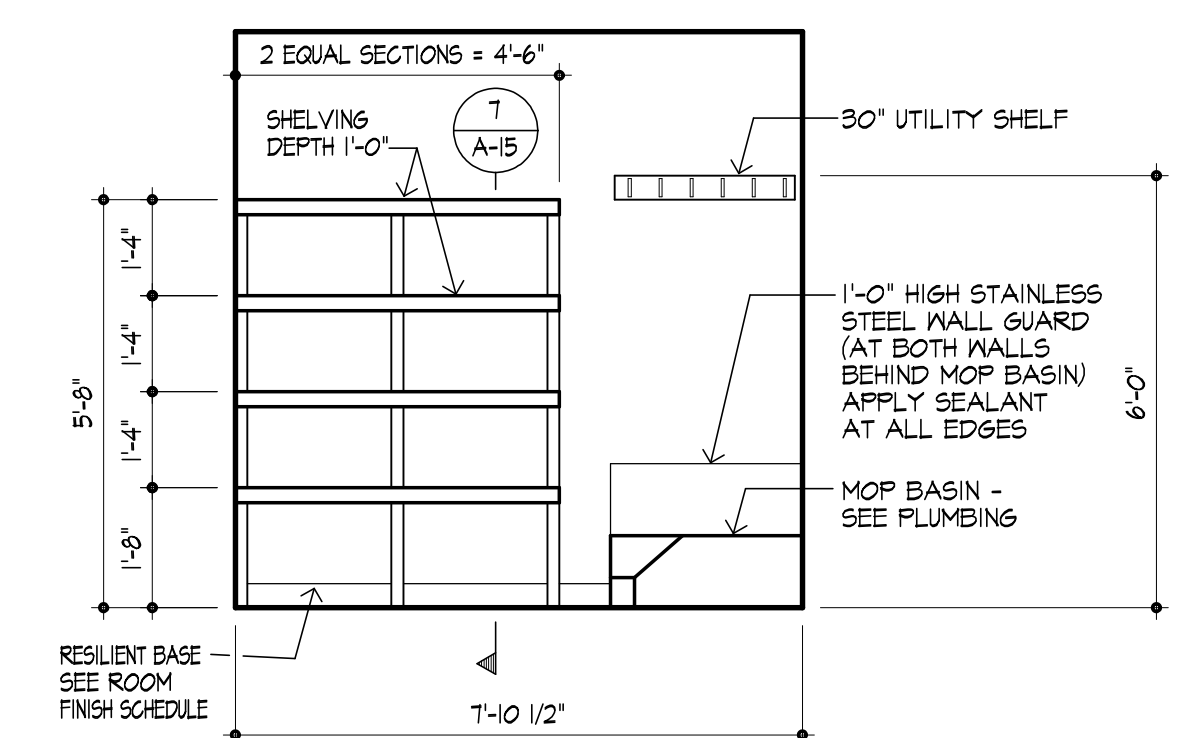

11 ELEVATION
JANITOR 119

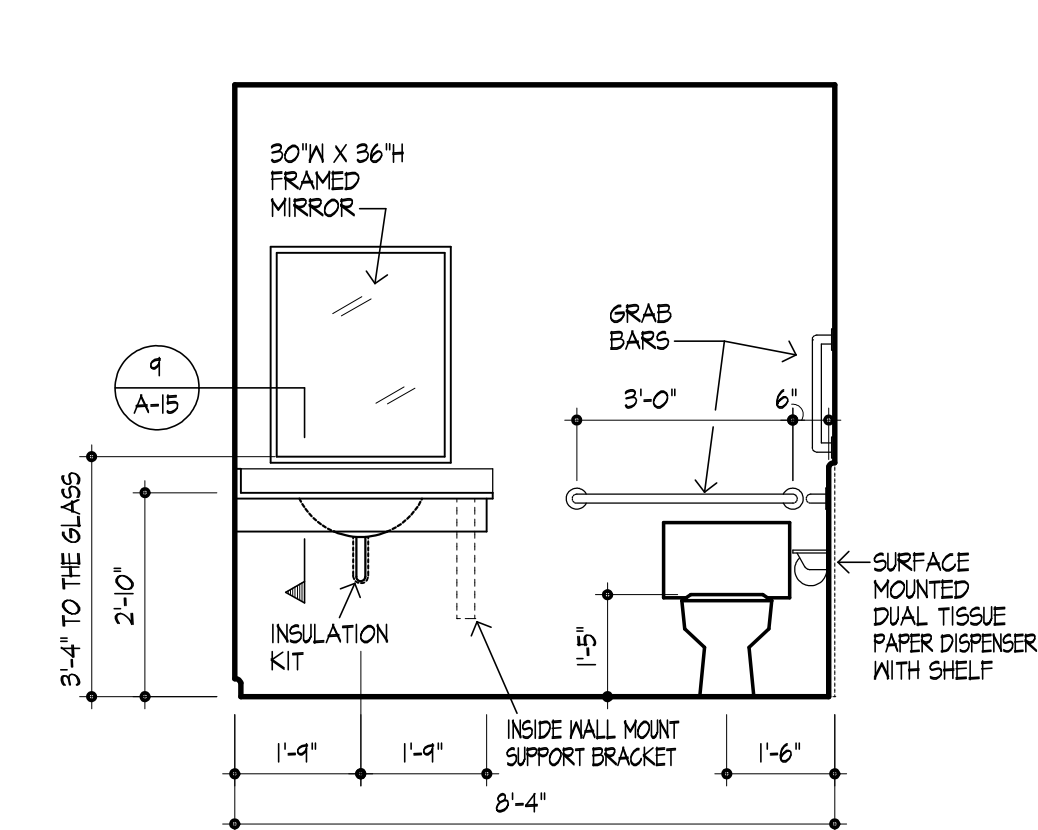

12 ELEVATION
MEN 122 & WOMEN 120 OPPOSITE HAND

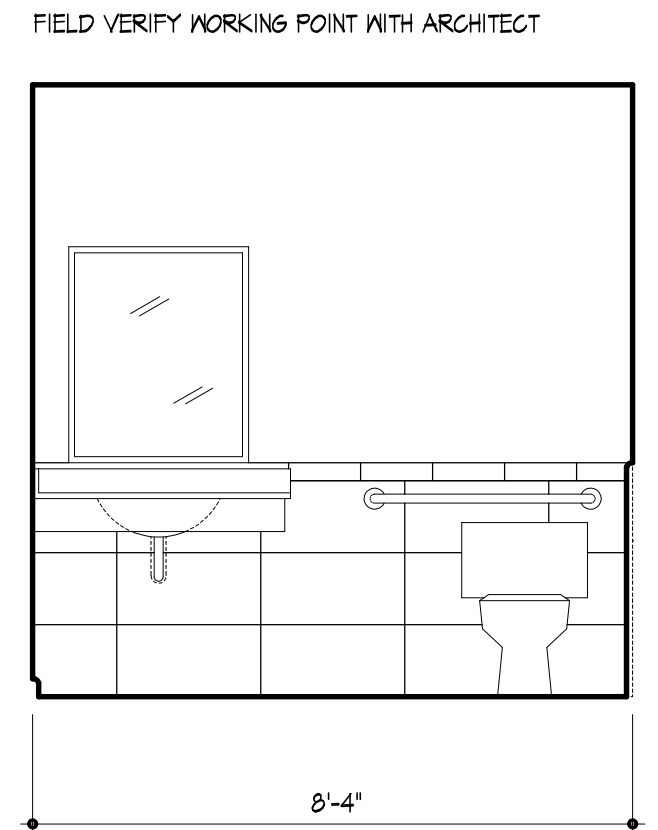

13 ELEVATION
MEN 122 & WOMEN 120 OPPOSITE HAND

THIS ELEVATION IS FOR TILE PATTERN REPRESENTATION ONLY. EACH WALL WITH WALL TILE IN TOILET 122 & 120 IS REPRESENTED IN ELEVATION. WALLS NOT REPRESENTED DO NOT HAVE WALL TILE.

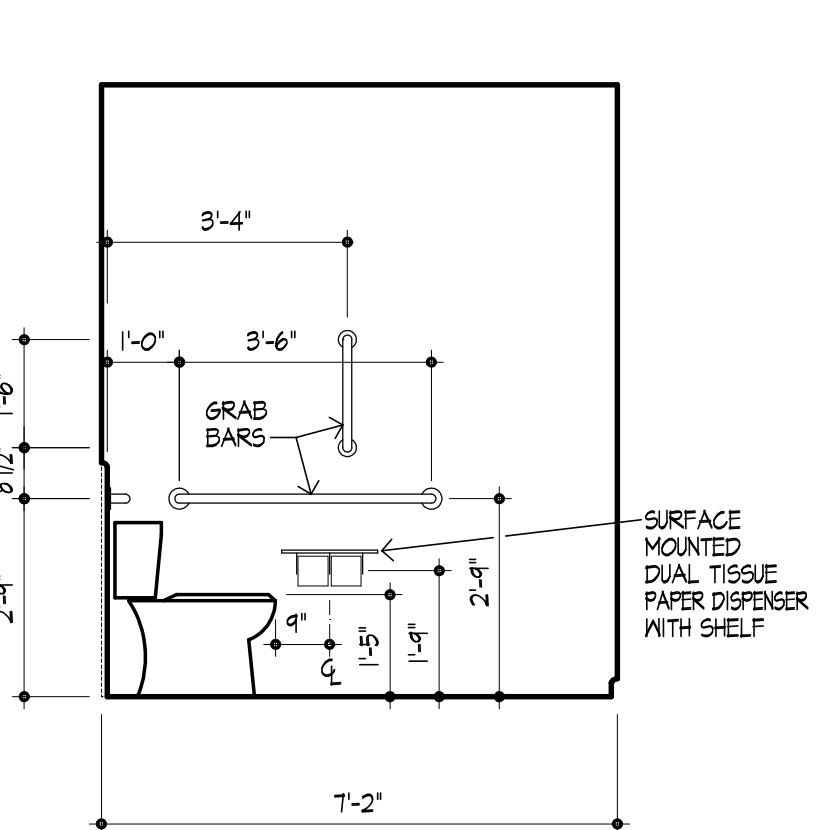

14 ELEVATION
MEN 122

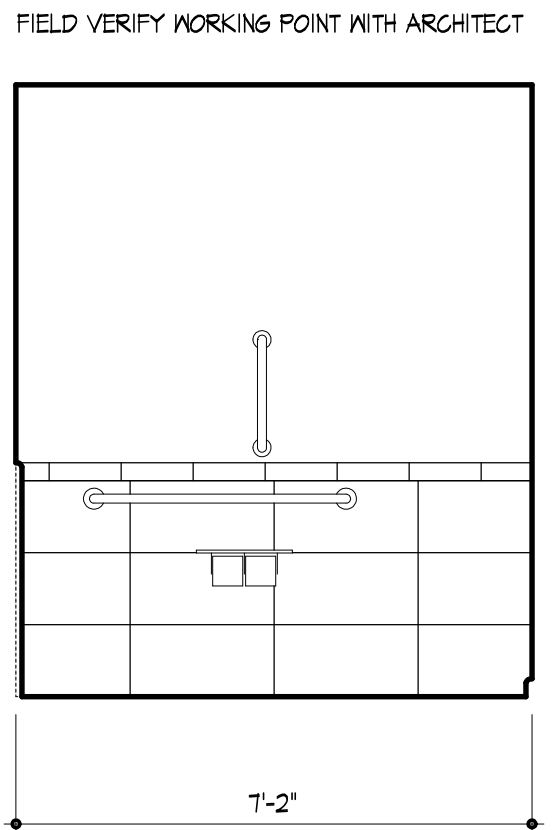

15 ELEVATION
WOMEN 120

THIS ELEVATION IS FOR TILE PATTERN REPRESENTATION ONLY. EACH WALL WITH WALL TILE IN MEN 122 IS REPRESENTED IN ELEVATION. WALLS NOT REPRESENTED DO NOT HAVE WALL TILE.

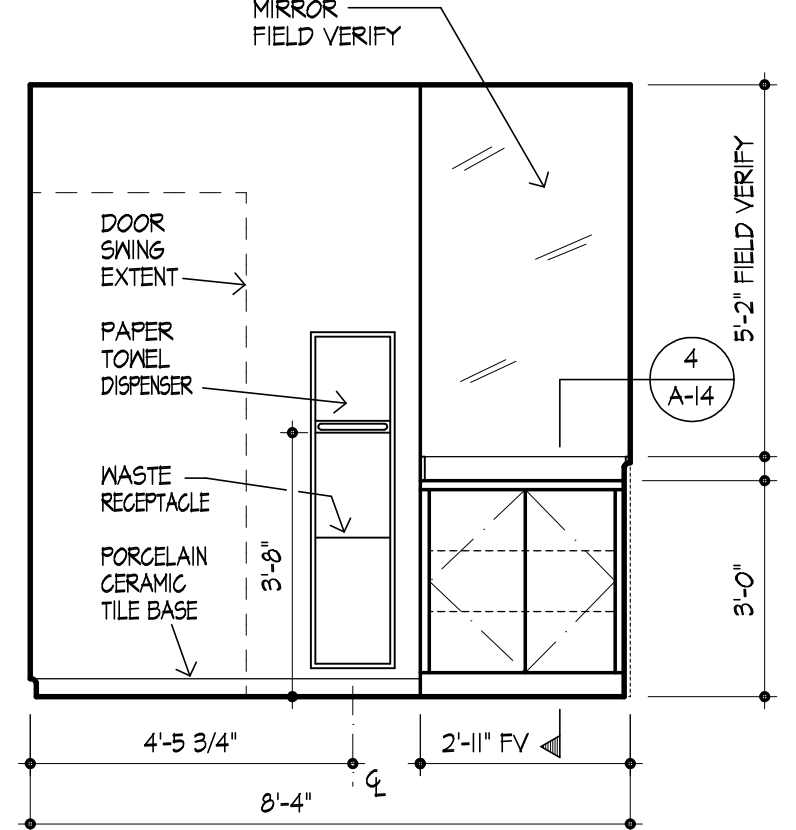
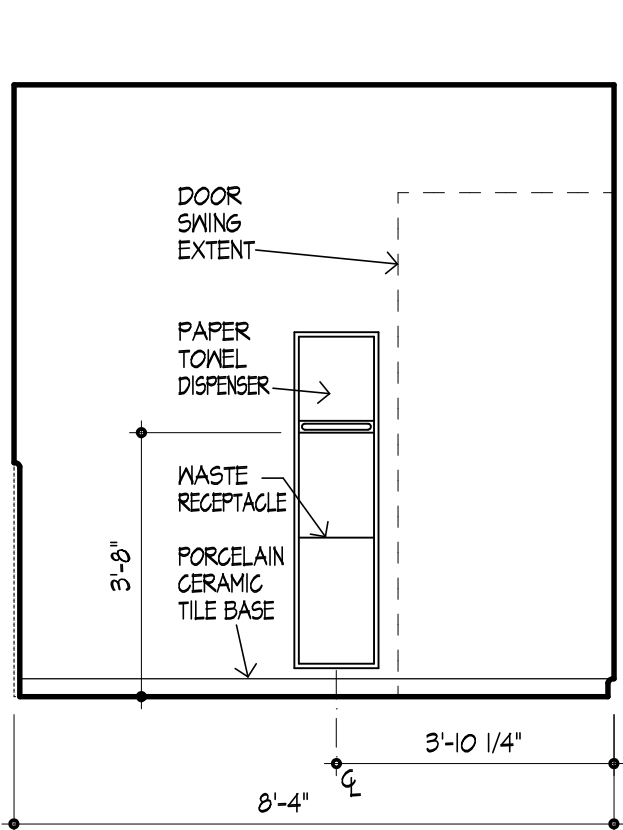

File Name: G:\2016\1612 T&F BANK DOUBLE SPRINGS\1612 WD\1612 A13 INTERIOR ELEVATIONS
Plot Date: 1/30/2018 Plot Time: 3:31 PM